

CCMC 13289-R

CCMC Canadian code compliance evaluation

CCMC number:	13289-R
Status:	Active
Issue date:	2007-10-09
Modified date:	2023-11-08
Evaluation holder:	<p>FIBERWEB, LLC 70 Old Hickory Boulevard Old Hickory TN 37138 United States Website: www.fiberweb.com Telephone: 615-847-7000</p>
Product name:	TYPAR®MetroWrap™ / TEKTON MetroWrap - Air Barrier Material
Compliance:	NBC 2015, OBC
Criteria:	CCMC-TG-072709.02-15E, "CCMC Technical Guide for Air Barrier Materials"

In most jurisdictions this document is sufficient evidence for approval by Canadian authorities.

[Learn more about CCMC recognition](#) [Look for the trusted CCMC mark on products to verify compliance.](#)

Compliance opinion

It is the opinion of the Canadian Construction Materials Centre that the evaluated product, when used as an air barrier material in accordance with the conditions and limitations stated in this evaluation, complies with the following code:

National Building Code of Canada 2015

Code provision	Solution type
5.4.1.2.(1) Except as provided in Sentence 5.4.1.2.(...	<u>Acceptable</u>
9.25.3.2. Air Barrier System Properties	<u>Alternative</u>
9.36.2.10.(1) Materials intended to provide the princi ...	<u>Acceptable</u>

Ontario Building Code

Ruling No. 08-03-188 (13289-R) authorizing the use of this product in Ontario, subject to the terms and conditions contained in the Ruling, was made by the Minister of Municipal Affairs and Housing on 2008-01-22 pursuant to s.29 of the Building Code Act, 1992 (see Ruling for terms and conditions). This Ruling is subject to periodic revisions and updates.

The above opinion(s) is/are based on the evaluation by the CCMC of technical evidence provided by the evaluation holder, and is bound by the stated conditions and limitations. For the benefit of the user, a summary of the technical information that forms the basis of this evaluation has been included.

Product information

Product name

TYPAR®MetroWrap™ / TEKTON MetroWrap - Air Barrier Material

Product description

This Report addresses the performance of the product as an air barrier material within the Fiberweb, LLC-specified “TYPAR® MetroWrap™/TEKTON MetroWrap – Air Barrier Material” air barrier system. The air barrier system has not been evaluated but is described in [Additional information: An air barrier material as part of an air barrier system](#) for the convenience of building officials and designers.

If the product is installed as part of the designated air barrier system as described, it will serve a dual function in the wall assembly: it will act as both an air barrier material and a sheathing membrane to control incidental water infiltration behind cladding. The latter function is covered in a separate CCMC Evaluation Report (CCMC 13286-R).

The product is produced from 100% polypropylene, spun-bonded olefin fabric made from oriented, isotactic, polypropylene filaments that have been thermally bonded and coated with a 0.0296-mm microporous copolymer film. The product is silver grey with a light grey backing and is 0.31 mm thick. It comes in rolls that are 3.048 m wide and 30.48 m long or 1.524 m wide and 45.72 m long.

Manufacturing plant

This evaluation is valid only for products produced at the following plant:

Product name	Manufacturing plant
	Old Hickory, TN, US
TYPAR®MetroWrap™ / TEKTON MetroWrap - Air Barrier Material	☑

☑ Indicates that the product from this manufacturing facility has been evaluated by the CCMC

Conditions and limitations

The CCMC's compliance opinion is bound by this product being used in accordance with the conditions and limitations set out below.

- The product has demonstrated a sufficiently low air permeance equivalent to the materials outlined in Table A-9.25.5.1.(1), Air and Vapour Permeance Values, and Sentence 9.36.2.10.(1), Construction of Air Barrier Details, of Division B of the NBC 2015 to be the principal plane of airtightness in an air barrier system.
- Generally, when the product is installed as part of the airtight element of the proponent's proprietary air barrier system, the vapour barrier only needs to comply with Sentences 9.25.4.2.(1) and (5), Vapour Barrier Materials, of Division B of the NBC 2015. In cases where another low water vapour permeance element has been installed in the wall assembly, Article 9.25.5.1., General (Properties and Position of Materials in the Building Envelope), of Division B of the NBC 2015 must apply.
- The product must be installed:
 - with the printed side facing outward and protected from exposure to ultraviolet (UV) radiation from the sun within 60 days;
 - with a minimum 10-mm air space between the sheathing membrane and the cladding, unless the cladding has been deemed not to require an air space (e.g., by the CCMC or by building officials based on past cladding performance); and
 - according to the most recent update of Fiberweb, LLC's "TYPAR® MetroWrap™ / TEKTON MetroWrap " Installation Instructions (sheathing membrane, air barrier and header wrap) (examples of the installation details are presented in Additional information: An air barrier material as part of an air barrier system).
- A concealed air space exceeding 25 mm in width must contain proper fire blocking, in accordance with Subsection 9.10.16., Fire Blocks, of Division B of the NBC 2015.
- CCMC-evaluated sheathing tape, in accordance with MasterFormat 07 25 20, must be used to seal all joints.
- The product must be clearly identified with the phrase "CCMC 13289-R."

Technical information

This evaluation is based on demonstrated conformance with the following criteria:

Criteria number	Criteria name
CCMC-TG-072709.02-15E	CCMC Technical Guide for Air Barrier Materials

The Report Holder has submitted technical documentation for the CCMC's evaluation. Testing was conducted at laboratories recognized by the CCMC. The corresponding technical evidence for this product is summarized below.

The durability assessment of "TYPAR® MetroWrap™ / TEKTON MetroWrap" is covered under CCMC 13286-R and the additional aging in CAN/ULC-S741-08, "Standard for Air Barrier Materials – Specification," is covered under this Report.

Performance requirements

Table 1. Results of testing of the performance requirements for the product

Test	Requirement	Result
Tested as per CAN/ULC-S741 with five 1-m² membrane specimens and measured for air permeance at a minimum of six air pressure differentials (ΔP) between 0 and 300 Pa – unconditioned (prior to UV and heat aging).	Air leakage rate at 75 Pa ΔP (based on linear regression of 30 data points) ≤ 0.02 L/(s·m ²)	0.0025 L/(s·m ²)
Five 1-m² membrane specimens tested and measured for air permeance at a minimum of six air pressure differentials (ΔP) between 0 and 300 Pa – conditioned (after UV and heat aging).	Where less than 0.01 L/(s·m ²) for unconditioned specimens, the increase of the air leakage rate at 75 Pa ΔP for conditioned specimens ≤ 0.001 L/(s·m ²).	0.0032 L/(s·m ²) ⁽¹⁾
		0.0007 L/(s·m ²) ⁽²⁾
Water vapour permeance (infiltration direction)	Where less than 60 ng/(Pa·s·m ²), the location of the product installation is restricted by the requirements listed in Article 9.25.1.1. of Division B of the NBC 2015.	424.9 ng/(Pa·s·m ²)
Water vapour permeance (exfiltration direction)		475.7 ng/(Pa·s·m ²)

Notes:

- ¹ Test result (air leakage rate) for the conditioned specimens after UV and heat aging.
- ² Increase of the air leakage rate for conditioned specimens after UV and heat aging.

Additional information: An air barrier material as part of an air barrier system

The CCMC has not evaluated the performance of the "TYPAR® MetroWrap™ / TEKTON MetroWrap" air barrier system in conformance with Article 9.25.3.2., Air Barrier System Properties, of Division B of the NBC 2015. However, the CCMC's opinion is that an air barrier system using this material and installed in conformance with the details outlined below, as well as in Fiberweb, LLC's "TYPAR® MetroWrap™ / TEKTON MetroWrap" installation manual, should satisfy the requirements for continuity of the air barrier system in Articles 9.25.3.1., Required Barrier to Air Leakage, and 9.25.3.3., Continuity of the Air Barrier System, of Division B of the NBC 2015.

This PDF is an alternative version. This document was published on 2024-02-29 and may not be the latest version of this evaluation. Users should consult the latest [published assessment](#) on the [CCMC Registry of Product Assessments](#), which contains the most up to date information. This PDF is intended for use as a record, not the latest information available.

Discussion

Authorities having jurisdiction (AHJ) should be aware that this system differs from the typical air barrier approach, which uses a flexible membrane as the principal plane of airtightness. In the typical approach, the membrane (i.e., polyethylene sheet) is sandwiched between two other materials so that it is not required to resist, on its own, the full force of indoor/outdoor pressure differences induced by stack effect, mechanical systems and, most importantly, wind.

In a system in which the membrane is applied to the outer surface of the wall sheathing, as it is in the proposed air barrier system, the membrane does not have continuous support against outward air pressure; it must, therefore, have adequate strength to resist that pressure where it spans between points of support, such as its own fastening points or the points where strapping or cladding are fastened to the wall. The CCMC's evaluation of this material **does not include the evaluation of this strength** or the strength of the continuity details. The AHJ must, therefore, determine whether the product's air barrier system, described herein, meets the intent of Sentence 9.25.3.2.(1), Air Barrier System Properties, of Division B of the NBC 2015, as being an effective barrier for the proposed construction in the proposed geographical/climate area. For example, based on their experience, the AHJ may deem the proposed air barrier system adequate for buildings in urban areas, sheltered sites or areas of low wind, but inadequate for buildings in areas of high wind and exposed sites in rural or coastal areas.

An air barrier system checklist for the AHJ to consider is below. An air barrier system must:

- i. have an acceptable low air leakage rate;
- ii. be continuous;
- iii. be durable;
- iv. have sufficient strength to resist the anticipated air pressure load; and
- v. be buildable in the field.

Installation details

The product is applied over exterior wood-based wall sheathing material complying with the NBC 2015. It does not contribute to an air barrier system until it is joined to the other components that make up the air barrier system of the building. The product's installation manual outlines how the product must be joined to the foundation wall, to windows and doors, to penetrations in the wall and to the ceiling air barrier, thus forming the system.

A successful air barrier system installation is predicated on sequencing during construction. Coordination is required during erection of framing and after completion of the system to ensure that no other trade breaches the integrity of the installed air barrier system.

The proposed air barrier system is defined as possessing the following features:

- i. "TYPAR® MetroWrap™ / TEKTON MetroWrap" – Air Barrier Material as the principal plane of airtightness;
- ii. accessories (including sealants and CCMC-evaluated sheathing tape) to maintain continuity at junctions with penetrations in the wall assembly (i.e., windows, doors, pipes, ducts, electrical outlets, etc.) and in accordance with continuity details in the product's installation manual;
- iii. durable, meeting UV and heat-aging requirements;
- iv. exterior sheathing with specified fasteners and fastening schedule of the "TYPAR® MetroWrap™ / TEKTON MetroWrap" for structural support against anticipated pressure loads; and
- v. the air barrier system is to be built in the field by informed builders and reviewed by building officials.

The figures below outline typical construction details on the installation of the product as an air barrier system in the field. See the product's installation manual for additional details.

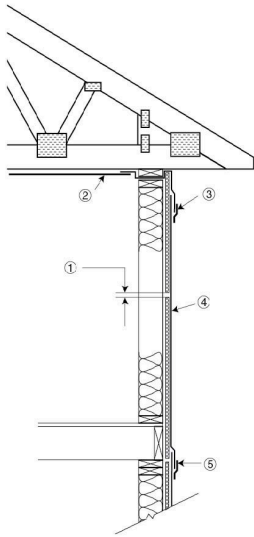

Figure 1. Exterior wall cross-section of the product - top wall/ceiling continuity

1. Wood-based sheathing installed with open horizontal gap
2. Ceiling air/vapour barrier
3. CCMC-evaluated sheathing tape
4. Proprietary air barrier material
5. Typical overlap of 100 mm of the proprietary air barrier material and tape

All horizontal joints in the material must be overlapped 100 mm and taped with CCMC-evaluated sheathing tape. To maintain continuity of the plane of airtightness, the material must be sealed to the roof using an appropriate transition membrane. The material should be secured underneath the transition membrane to ensure proper shingling. Wood-based sheathing, glass-fibre-faced exterior gypsum board, or exterior gypsum board having a water vapour permeance of less than $60 \text{ ng}/(\text{Pa}\cdot\text{s}\cdot\text{m}^2)$ must be installed in accordance with Article 9.25.5.2., Position of Low Permeance Materials, of Division B of the NBC 2015.

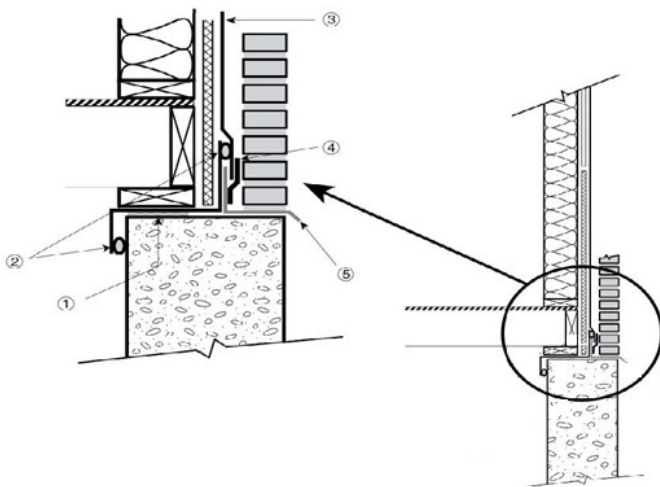

Figure 2. Bottom foundation detail for the product

This PDF is an alternative version. This document was published on 2024-02-29 and may not be the latest version of this evaluation. Users should consult the latest [published assessment](#) on the [CCMC Registry of Product Assessments](#), which contains the most up to date information. This PDF is intended for use as a record, not the latest information available.

1. Sill plate gasket
2. Sealant
3. Proprietary air barrier material
4. Tape
5. Flashing

Since the foundation wall is part of the air barrier system, the product must be sealed to the foundation wall to maintain the continuity of the plane of airtightness. The sealant used must be compatible with the product (for example, silicone-based sealants must not be used). To maintain watertightness, the product's sheathing membrane must be installed over the flashing and taped to properly drain any rain penetration breaching the cladding.

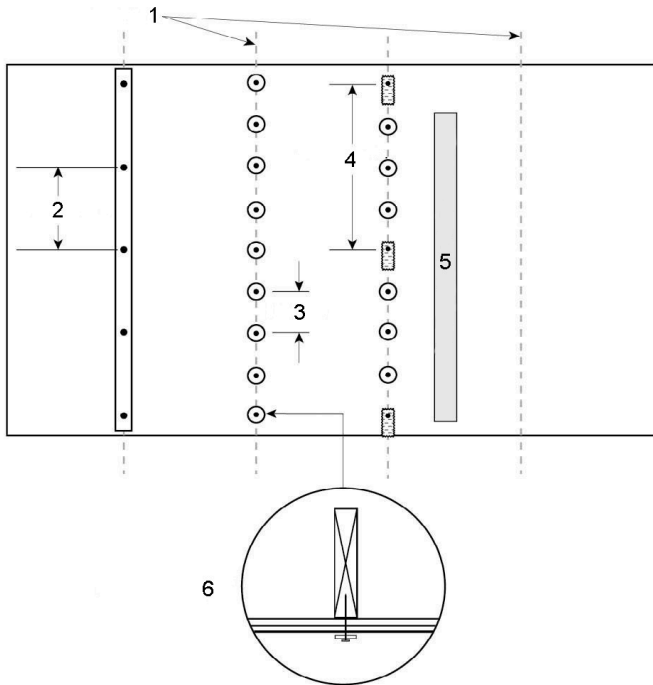

Figure 3. Structural fasteners for the product

1. Stud centerlines
2. 300 mm o.c.
3. 150 mm o.c.
4. 600 mm o.c.
5. Overlap & tape vertical seams
6. 25 mm cap nails or brick ties to be installed 150 mm o.c. into stud

When installed as the principal plane of airtightness, the product must be structurally attached using nails with plastic washers, screws with plastic washers, or appropriate brick tie anchors.

For wood-framed construction where the sheathing is either plywood, insulated board, glass-fibre-faced exterior gypsum, or exterior gypsum board, use nails with plastic washers and brick tie anchors.

For steel-framed construction where the sheathing is either glass-fibre-faced exterior gypsum or exterior gypsum, use screws with washers and brick tie fasteners.

All seams require a 100-mm minimum overlap and both vertical and horizontal seams should be secured with a CCMC-evaluated sheathing tape.

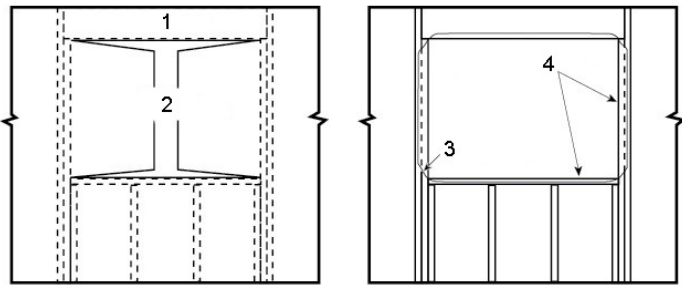

Figure 4. Window and door openings

1. Outside view
2. Make an inverted "Y" cut in membrane
3. Tape cut corners
4. Fasten proprietary barrier material to sides and bottom

The material must be cut and wrapped around framing at openings (see [Figure 4](#)). Cut ends should then be taped or caulked to the inside frame. To ensure continuity at this junction, a seal must be established with the window or door element (see [Figure 5](#)).

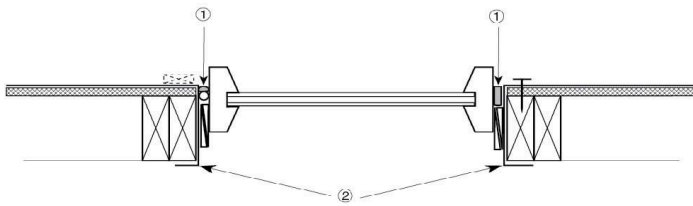

Figure 5. Window frame cross-section

1. Seal to window with sealant or foam compatible with proprietary air barrier material and wood/vinyl/aluminum frames
2. Proprietary air barrier material

The plane of airtightness of the material must be made continuous with windows and doors that are part of the air barrier system for the building envelope. The material must be sealed to the window or door frames with either sealant/backer rod or filled with sealant foam. Sealants must be compatible with the material and adhere to the framing material.

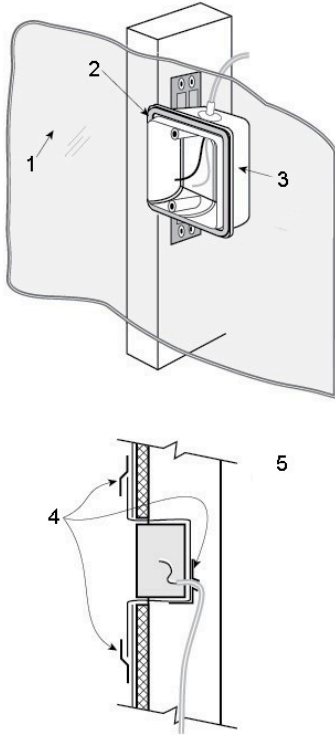

Figure 6. Exterior electrical boxes

1. Proprietary air barrier material installed on sheathing but not shown for clarity
2. Snap-on retainer
3. Airtight plastic box
4. Tape seal
5. Seal exterior electrical outlet boxes or use airtight plastic boxes

All exterior electrical boxes or other penetrations through the material must be rendered airtight to maintain the plane of airtightness of the air barrier system. All electrical boxes must be wrapped and taped to the product's membrane, or airtight electrical boxes can be used.

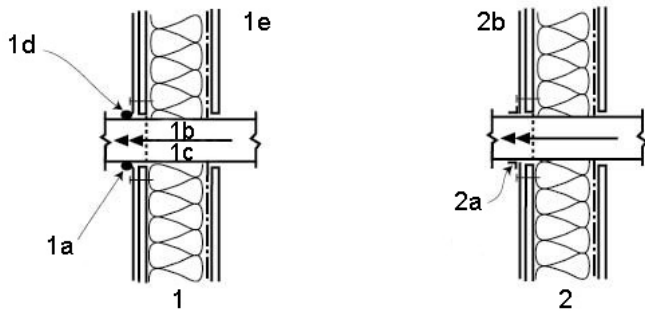

Figure 7. . Sealing at wall penetrations

1. Method One
 - a. Proprietary air barrier material around opening
 - b. Air flow
 - c. Exhaust

- d. Seal around opening
 - e. Inside
2. Method Two
- a. Trim proprietary air barrier material around opening and tape connection
 - b. Outside

Where pipes and ducts breach the product's membrane, they must be sealed to the membrane. A sealant bead or CCMC-evaluated sheathing tape compatible with the product and the pipe or duct material is recommended.

Administrative information

Use of Canadian Construction Materials Centre (CCMC) assessments

This assessment must be read in the context of the entire [CCMC Registry of Product Assessments](#), any applicable building code or by-law requirements, and/or any other regulatory requirements (for example, the [Canada Consumer Product Safety Act](#), the [Canadian Environmental Protection Act](#), etc.).

It is the responsibility of the user to confirm that the assessment they are using is current and has not been withdrawn or superseded by a later version on the [CCMC Registry of Product Assessments](#).

Disclaimer

The National Research Council of Canada (NRC) has evaluated only the characteristics of the specific product described herein. The information and opinions in this evaluation are directed to those who have the appropriate degree of experience to use and apply its contents (such as authorities having jurisdiction, design professionals and specifiers). This evaluation is valid when the product is used as part of permitted construction, respecting all conditions and limitations stated in the evaluation, and in accordance with applicable building codes and by-laws.

This evaluation is provided without representation, warranty or guarantee of any kind, expressed or implied, and the NRC provides no endorsement for any evaluated product. The NRC accepts no responsibility whatsoever arising in any way from any and all use of or reliance on the information contained herein or the use of any evaluated product. The NRC is not undertaking to render professional or other services on behalf of any person or entity nor to perform any duty owed by any person or entity to another person or entity.

Language

Une version française de ce document est disponible.

In the case of any discrepancy between the English and French version of this document, the English version shall prevail.

Copyright

© His Majesty the King in Right of Canada, as represented by the National Research Council of Canada, 2024

All rights reserved. No part of this publication may be reproduced, stored in a retrieval system, or transmitted in any form or by any means, electronic, mechanical, photocopying, recording or otherwise, without the prior written permission of the CCMC.

This PDF is an alternative version. This document was published on 2024-02-29 and may not be the latest version of this evaluation. Users should consult the latest [published assessment](#) on the [CCMC Registry of Product Assessments](#), which contains the most up to date information. This PDF is intended for use as a record, not the latest information available.

CCMC recognition

The Canadian Construction Materials Centre (CCMC) assesses compliance with Canadian building, energy and safety codes. We are the only construction code compliance service supported and operated by the Government of Canada. Trusted by over 6,000 regulators across Canada.

Most Canadian authorities having jurisdiction (AHJs) consider CCMC product assessments acceptable as evidence for product approval.

CCMC assessments are recognized by construction authorities across Canada:

Alliance of Canadian Building Official Associations (ACBOA)



[\(Alliance of Canadian Building Official Associations \(ACBOA\)\)](#)

First Nations National Building Officers Association (FNNBOA)



[\(First Nations National Building Officers Association \(FNNBOA\)\)](#)

Canadian Home Builders' Association (CHBA)



[\(Canadian Home Builders' Association \(CHBA\)\)](#)

Alberta Building Officials Association (ABOA)



[\(Alberta Building Officials Associations \(ABOA\)\)](#)

Saskatchewan Building Officials Association (SBOA)



[\(Saskatchewan Building Officials Association \(SBOA\)\)](#)

Manitoba Building Officials Association (MBOA)



[\(Manitoba Building Officials Association \(MBOA\)\)](#)

Ontario Building Officials Association (OBOA)



[\(Ontario Building Officials Association \(OBOA\)\)](#)

New Brunswick Building Officials Association (NBBOA)



[\(New Brunswick Building Officials Association \(NBBOA\)\)](#)

Nova Scotia Building Officials Association (NSBOA)



[\(Nova Scotia Building Officials Association \(NSBOA\)\)](#)

The CCMC provides code compliance assessments to Canadian code requirements, consulting nationwide with construction regulators to elicit regional variations in code requirements as well as provincial and local interpretations. Users are advised to review the technical information presented in CCMC assessments when making approval decisions. [Learn more about how the CCMC provides a unique service for Canada.](#)

For more information, contact the CCMC by phone at (613) 993-6189 or by email at ccmc@nrc-cnrc.gc.ca

NOTICE

The information presented on this webpage (in HTML format) is the most up-to-date information available from the CCMC about this assessment.

By downloading this PDF you acknowledge that:

- this PDF is intended for record-keeping purposes only,
- it represents the information as it was available at the time of downloading, and
- it may not reflect the latest available information at some future date.

References to this CCMC assessment (in product literature, on websites, etc.) must be made by linking to the evaluation webpage. **This PDF must not be used as a means of distributing this assessment to an audience.**

[View PDF \(Portable document format\)](#)

Code compliance as an acceptable solution

Code Compliance via Acceptable Solutions

If a building design (e.g. material, component, assembly or system) can be shown to meet all provisions of the applicable **acceptable solutions** in Division B (e.g. it complies with the applicable provisions of a referenced standard), it is deemed to have satisfied the objectives and functional statements linked to those provisions and thus to have complied with that part of the Code.

— National Building Code of Canada, Sentence A-1.2.1.1.(1)(a)

The CCMC has determined that compliance with this provision of the Code has been demonstrated as an **Acceptable Solution**. The evaluation report provides a summary of the basis of CCMC's compliance opinion.

CCMC's code compliance opinions

All CCMC evaluation reports are opinions of code compliance established in accordance with the National Building Code of Canada, Subsection 1.2.1. "Compliance with this Code," which requires compliance to be achieved by:

- complying with the applicable acceptable solutions in Division B, or
- using an alternative solution that will achieve at least the minimum level of performance required by Division B in the areas defined by the objective and functional statements attributed to the applicable acceptable solutions.

The CCMC assesses compliance with Canadian building, energy and safety codes, and is trusted by over 6,000 regulators across Canada.

Code compliance as an alternative solution

Code Compliance via Alternative Solutions

Where a design differs from the acceptable solutions in Division B, then it should be treated as an **"alternative solution."** A proponent of an alternative solution must demonstrate that the alternative solution addresses the same issues as the applicable acceptable solutions in Division B and their attributed objectives and functional statements. However, because the objectives and functional statements are entirely qualitative, demonstrating compliance with them in isolation is not possible. Therefore, Clause 1.2.1.1.(1)(b) identifies the principle that Division B establishes the quantitative performance targets that alternative solutions must meet. In many cases, these targets are not defined very precisely by the acceptable solutions [...] Nevertheless, Clause 1.2.1.1.(1)(b) makes it clear that an effort must be made to demonstrate that an alternative solution will perform as well as a design that would satisfy the applicable acceptable solutions in Division B—not “well enough” but “as well as.”

— National Building Code of Canada, Sentence A-1.2.1.1.(1)(b)

The CCMC has determined that compliance with this provision of the Code has been demonstrated as an **Alternative Solution**. The evaluation report provides a summary of the basis of CCMC's compliance opinion.

CCMC's code compliance opinions

All CCMC evaluation reports are opinions of code compliance established in accordance with the National Building Code of Canada, Subsection 1.2.1. "Compliance with this Code," which requires compliance to be achieved by:

- complying with the applicable acceptable solutions in Division B, or
- using an alternative solution that will achieve at least the minimum level of performance required by Division B in the areas defined by the objective and functional statements attributed to the applicable acceptable solutions.

The CCMC assesses compliance with Canadian building, energy and safety codes, and is trusted by over 6,000 regulators across Canada.